

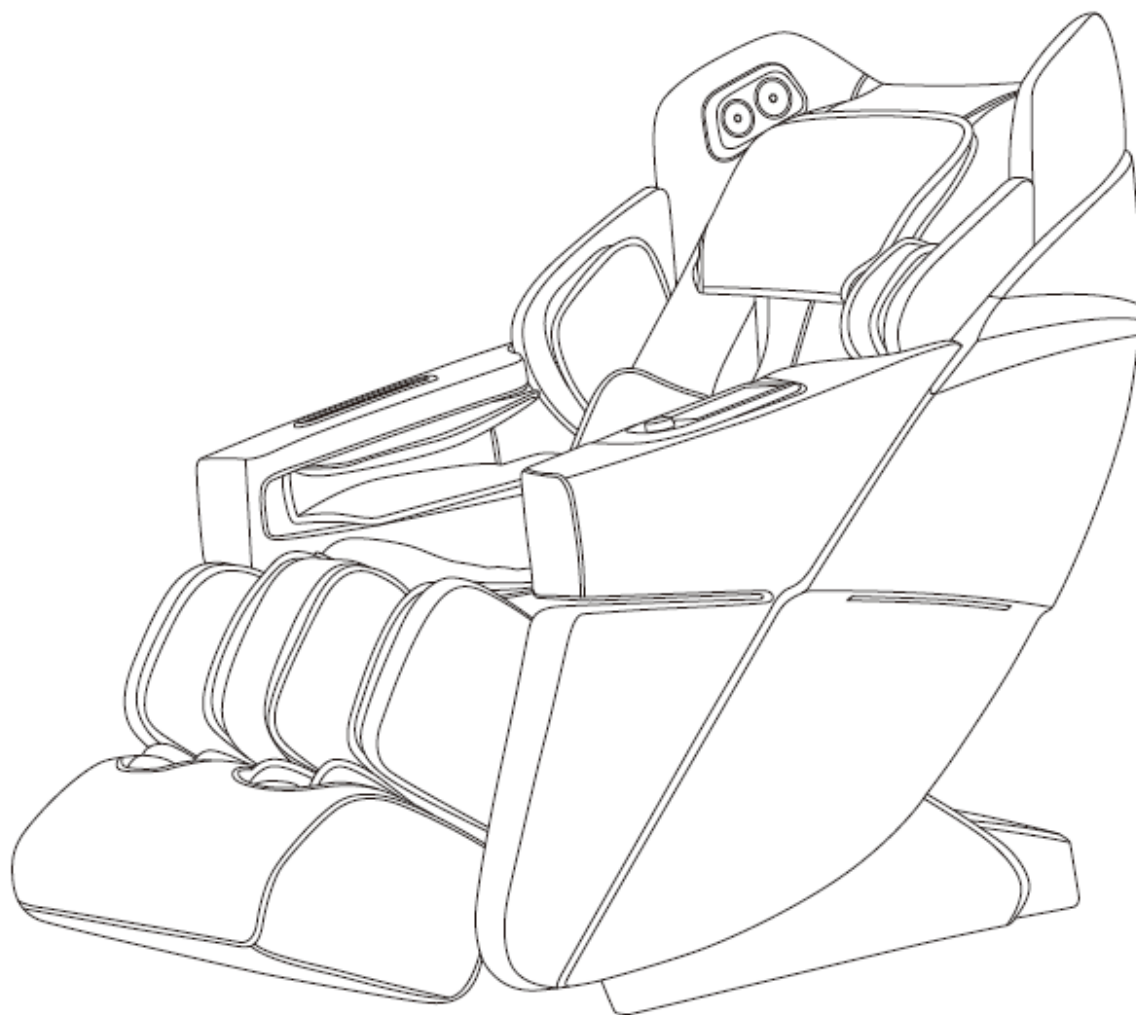

**USER MANUAL – EN**

**IN 23635 Massage chair inSPORTline Lorreto**



# CONTENTS

- SAFETY INSTRUCTIONS..... 3
- WARNING ..... 5
- PRODUCT DESCRIPTION ..... 6
- FUNCTIONS..... 7
- CONTROLLER ..... 8
- USE ..... 9
  - CONNECTION..... 9
  - TURN ON..... 9
  - ADJUSTING THE ANGLE OF THE RESTS..... 9
  - MESSAGE LOCATION..... 10
  - PAUSE..... 11
  - MENU..... 11
  - AUTOMATIC MESSAGES..... 12
- MANUAL PROGRAMS..... 13
- OTHER ..... 14
  - UPPER BODY AIRBAGS ..... 14
  - LOWER BODY AIRBAGS..... 14
  - HEATING ..... 15
  - LEG KNEADING ..... 15
- CUSTOM MESSAGE ..... 16
  - SAVE..... 16
  - LOAD ..... 16
  - ANGLE ADJUSTMENT..... 17
- SETTINGS..... 19
- MESSAGE ADJUSTMENT..... 20
- QUICK SELECTION BUTTONS..... 23
- VOICE CONTROL..... 24
- BLUETOOTH..... 25
- SWITCH OFF THE CHAIR..... 25
- ASSEMBLY ..... 25
  - PILLOWS ..... 27
- FLOOR PROTECTION..... 28
- TRANSPORT..... 28
- SPECIFIKACE ..... 29
- ENVIRONMENT PROTECTION ..... 29
- TERMS AND CONDITIONS OF WARRANTY, WARRANTY CLAIMS..... 29

# **SAFETY INSTRUCTIONS**

## **IMPORTANT SAFETY WARNINGS**

- Place the product on flat and solid surface and keep at least 0.6 m free space around the product.
- Kids can move around this product only under adult supervision.
- Use only well-grounded socket and proper power cord.
- Pull out the plug after every use or during maintenance to avoid injury or damaging the product.
- Please use this product according to the manual.
- Do not use unauthorized modifications or accessories.
- Only for indoor use.
- Before first use, please read the manual carefully.
- Use this product as is described in the manual.
- Recommended maximum use time is 20 minutes.
- Do not use the device if it is damaged. (frame, leather etc.)
- Do not use the chair if the ventilation is blocked.
- No not put on chair heavy items or objects with sharp edge.
- Do not fall asleep during massage for safety reasons.
- Do not use the chair after you consumed alcohol or other drugs or if you are sick or dizzy.
- Do not use within one hour after meal.
- Please be caution and do not use too strong massage.
- Weight limit: 150 kg

## **POSITION OF MASSAGE CHAIR**

- Do not use the chair in high temperatures or moist environments (e.g. bathroom).
- Do not use the chair immediately after temperature change.
- Do not use in dust or impropriety rooms.
- In is important to secure enough space and ventilation.

## **PEOPLE THAT SOULD NOT USE THE PRODUCT**

- People suffering from osteoporosis.
- People who have hearth problems or are using electronic medical equipment (e.g. peacemaker).
- People suffering fever.
- Pregnant women.
- People suffering skin diseases.
- Kids younger 14 years old or people suffering mental illness can use this product only under adult supervision.
- People that are recommended rest from the doctor or people suffering from sickness.
- Do not use this chair if you have wet body.
- Do not use the heat function if you are heat sensitive.

## **SAFETY**

- Maintenance should be done only by qualified person. User should not disassemble the chair or do the maintenance by themselves.
- After every use unplug the cord.
- Do not use the product if the power cord, plug or socket are damaged.
- If you are not using the chair for long period of time, store it at a clean and dry place and secure the power cord.
- Do not expose the chair to high temperatures, direct sunlight and do not place the chair near heat source.
- If the power cord, plug or socket are damaged, ask professional or qualified person for help.
- For cleaning use wet sponge only. Do not use thinner, gasoline or alcohol for cleaning.
- Mechanical parts are assembled and made to require minimum maintenance.
- Pay extra attention to not damage the chair with sharp objects.
- Do not push the chair on uneven ground, always pick the chair up and then move.
- Do not let the chair to work for long periods of time.

## **COMMON PROBLEMS AND SOLUTIONS**

- It is common that the motor is making sounds.
- If the chair is not working, please check the power cord, plug and socket and that the switch is ON.
- After the massage time is over the massage chair will turn OFF. The product will automatically shut down if it is overheated – wait at least half an hour before next massage.

## WARNING

If the footrest rises, do not apply pressure to the footrest. You may damage the product or injure yourself.

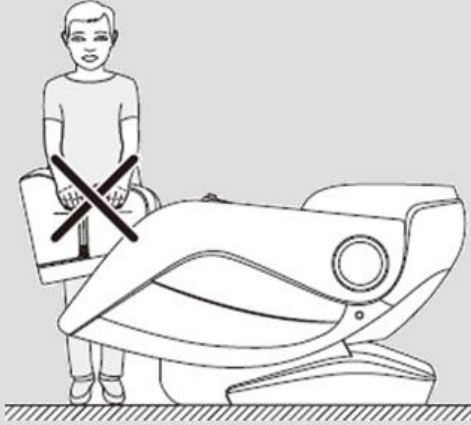

Before sitting down, make sure that the massage heads do not protrude from the seat. You may damage the heads or be injured.

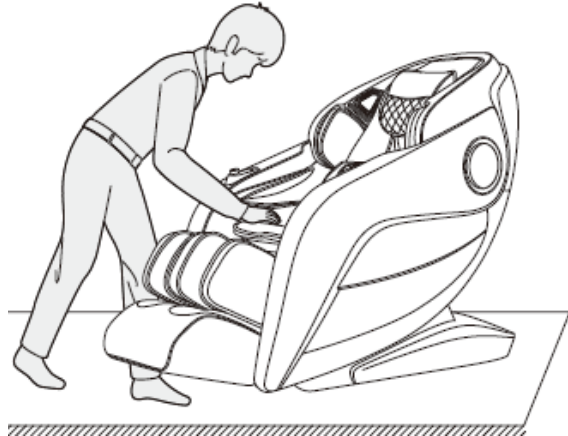

Never unplug the power cord during use or when the chair is in standby mode. After use, we recommend switching off the chair and unplugging the power cord.

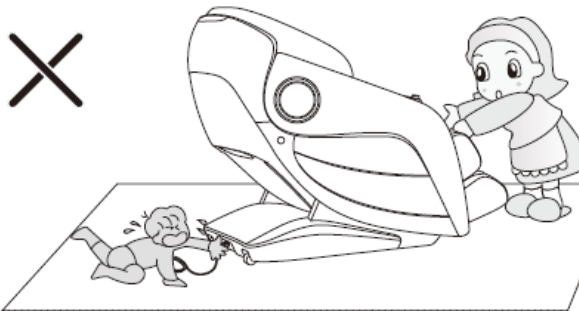

Before using the angle adjustment function, make sure that you have enough free space and that there are no other people or pets behind the chair.

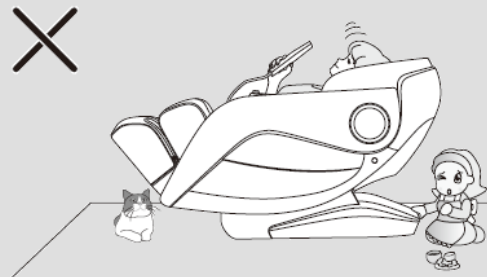

Do not carry any objects in your pockets during use.



Never unplug the chair during the massage.

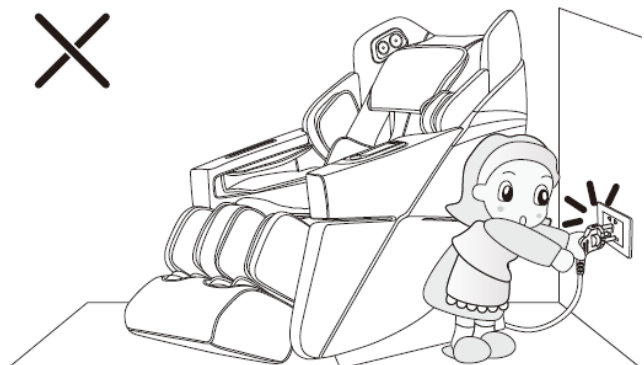

# PRODUCT DESCRIPTION

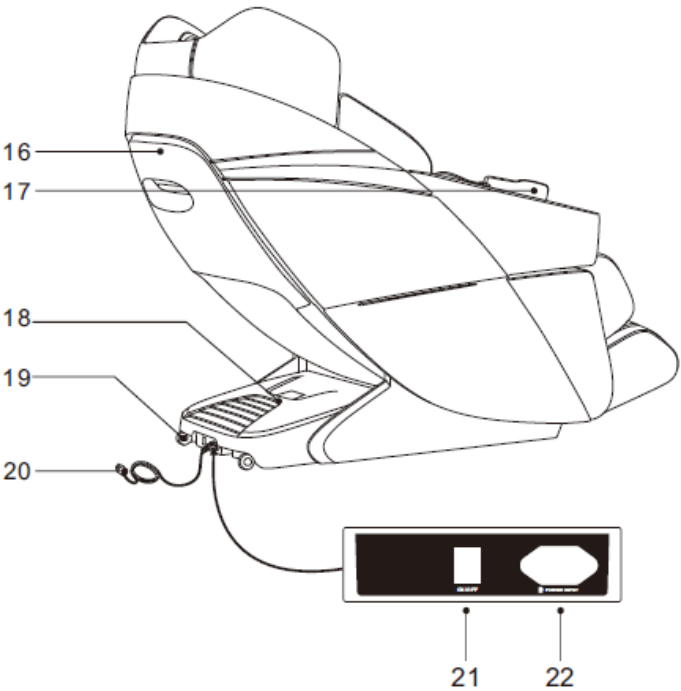
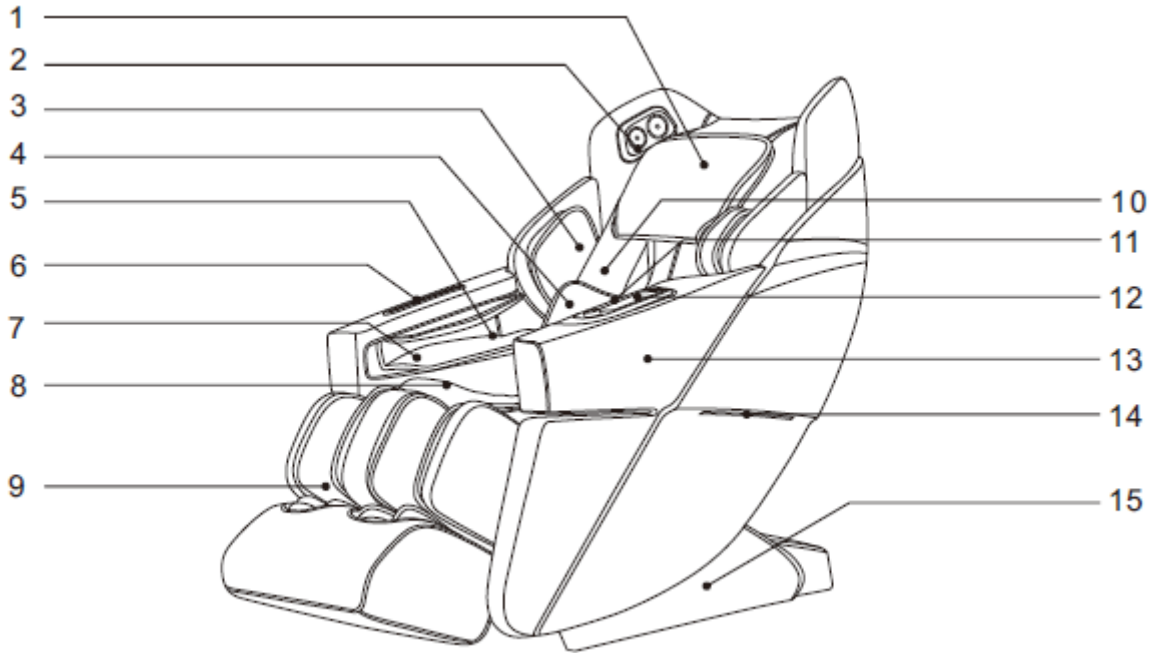

- 1. Pillow
- 2. 3D speakers
- 3. Upper arm airbags
- 4. Back airbags
- 5. Arm airbags
- 6. Controller holder
- 7. Palm massage
- 8. Seat
- 9. Leg rest
- 10. Backrest
- 11. Quick use buttons
- 12. Wireless charger
- 13. Armrest
- 14. LED lighting
- 15. Side cover
- 16. Backrest cover
- 17. Controller
- 18. Drive cover
- 19. Wheels
- 20. Power cord and plug
- 21. Switch
- 22. Connecting the power cord

## FUNCTIONS

- The chair contains a set of intelligent 3D massage heads with quiet operation; The massage heads move up, down, right, and left.
- The chair includes a function for detecting shoulders and body position, and Shiatsu points.
- 21 types of massages: fast, comfortable, relaxing, stretching, full body, neck & shoulder massage, back & waist, anti-stress, to replenish energy, for good sleep, relaxation of joints, spine, for people with office work, for rest after sports, neck & shoulder relaxation, mind restoration, spine relaxation, waist relaxation, leg relaxation and recovery.
- 5 positions for storing your own massage.
- Manual massage with the possibility of position: fixed, partial movement of the whole body, upper and lower back.
- Manual mode with 11 massage techniques: kneading (you can set up to 7 different modes in a cycle), tapping (two modes), simultaneous kneading and tapping, Shiatsu (two modes), shoulder massage, 3D massage (4 modes) and more.
- 7 types of massage adjustment: 5 speed settings, 5 intensity settings for back massage, 5 range settings, 5 width settings, 5 airbag force settings, 3 speeds for massage rollers, 4 massage timers.
- Upper body airbags: lower arm (8), upper arm (4), waist (4); 5 levels of intensity.
- Lower body airbags: legs (6), feet (22); 5 levels of intensity.
- Heated back using infrared light, carbon fibers are used for heating.
- The backrest uses rails, so it does not take up unnecessary space when angled.
- The backrest is ergonomically shaped for maximum user comfort.
- Voice control with enable button on the left.
- 3D speakers on both sides, Bluetooth connection.
- Wireless charging on the left side. You can also charge the device with a cable.
- On the left side there are controls for: Automatic massage, voice control (voice control on the remote controller must be switched on), heating, raising / lowering the leg rest, power switch, pause button and more.
- Airbags for the palms have inbuilt magnets.
- Possibility of automatic adjustment of the inclination of the rests.
- Legs kneading.
- Calves stretching.
- Independent adjustment of back and leg rests.
- Massage foot rollers.
- Adjustable length of the leg rest.
- LED lighting on the right and left side.
- Controller with color TFT display.
- Pillow with two layers.

# CONTROLLER

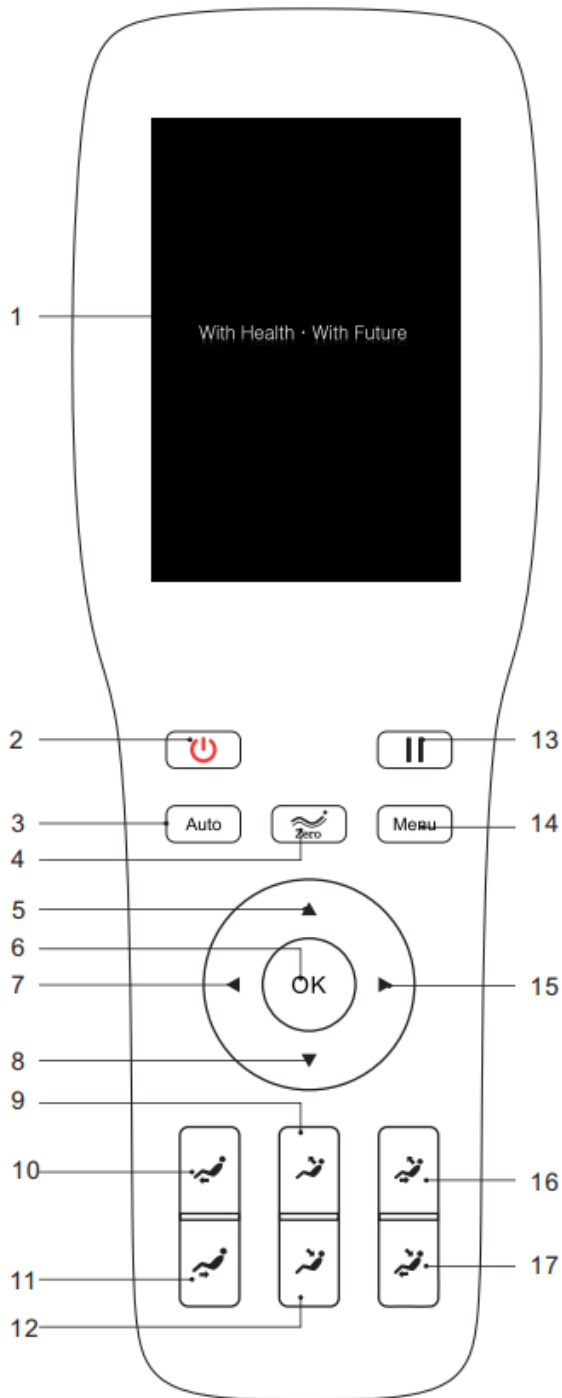

1. Color LCD TFT display

2. Power switch

3. Automatic massage

4. Position of zero gravity (3 levels, then the chair returns to its original position)

5. Navigation key up

6. Confirm button

7. Navigation key left

8. Navigation key down

9. Raising the backrest

10. Lifting the leg rest

11. Lowering the leg rest

12. Lowering the backrest

13. Pause

14. Menu

15. Right navigation button

16. Linked adjustment of the position of the backrest and leg rest

17. Linked adjustment of the position of the backrest and leg rest



# USE

## CONNECTION

Plug to socket

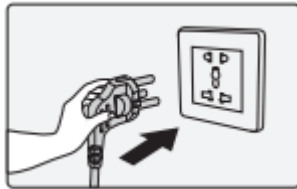

Plug to chair



Turn on the switch

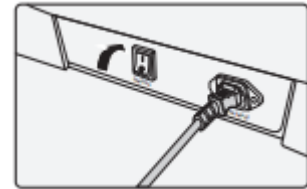

## TURN ON

Once started, the chair switches to standby mode. You can use the angle adjustment buttons and voice control to wake up.

Press the power switch, the massage selection interface is displayed. The backrest remains in its original position and the leg rest is raises slightly. Choose one of the automatic massages, if you do not select any function within 5 minutes, the chair will turn off automatically.

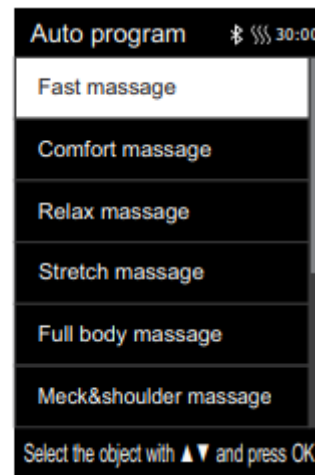

## ADJUSTING THE ANGLE OF THE RESTS

After selecting the automatic massage, the chair will automatically start adjusting the positions of the backrests and leg rests to the preset positions.

After adjusting the positions of the rests, the chair will automatically detect the position of the shoulders and the shape of the body. Wait for it to finish or press "ok" to skip detection.

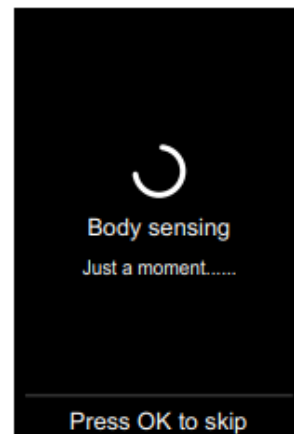
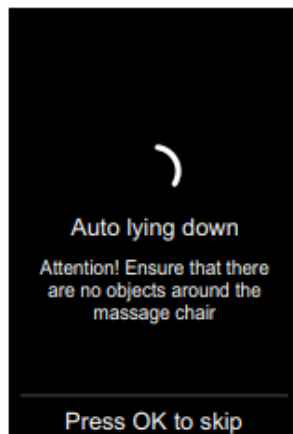



## ADJUSTMENT OF THE MASSAGE HEADS OF THE SHOULDERS

An audible signal sounds after the arm massage heads have been adjusted automatically. If you want to adjust the position of the heads, adjust the position using the up and down buttons. You can adjust the position in 11 levels. If the position is not adjusted within 10 seconds, the massage will start automatically. Press "ok" to skip the adjustment of the massage heads. If the chair cannot detect the position of the shoulders, the massage heads are adjusted according to the preset values.

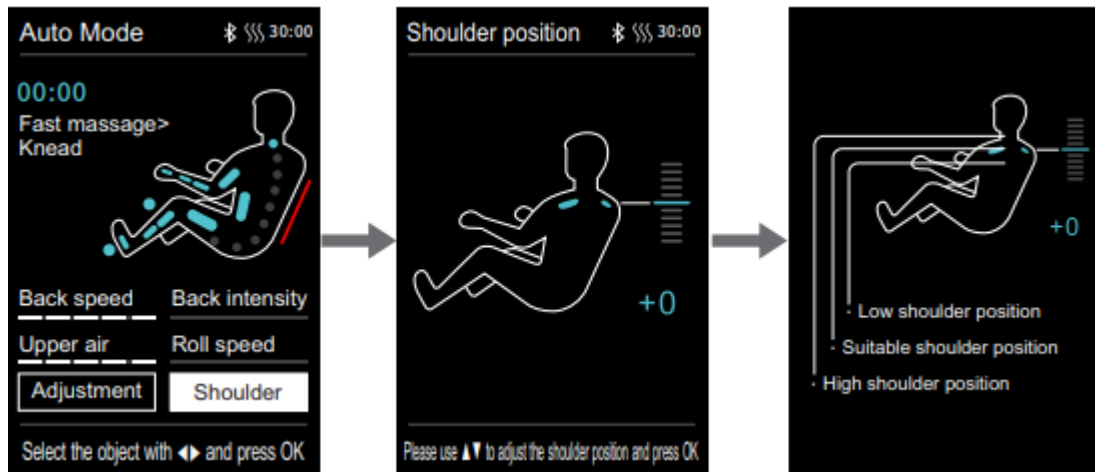
Note: During the massage, you can press the right button in the information interface and select "shoulder adjustment" to enter the shoulder position setting. You can then adjust the position using the up and down buttons.



Button	Description
	Moves the massage head up
	Moves the massage head down

If you need to adjust the position of the shoulders during the massage, select "shoulder position adjustment" to enter the interface. Use the up and down buttons to adjust the position, you can press the left button to return the previous interface or wait 10 seconds.

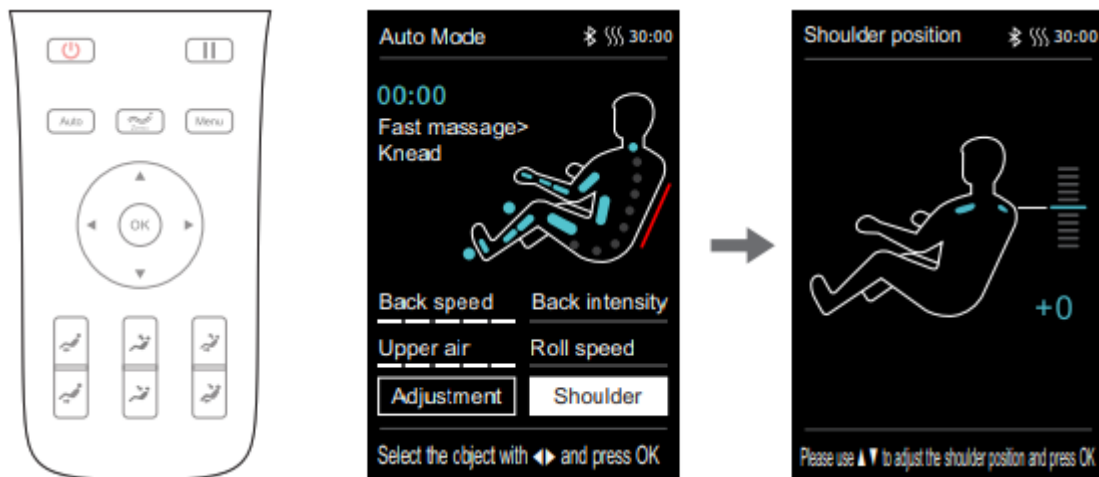

## MESSAGE LOCATION

After entering the massage program, if you need to change the massage location, you can press "menu" or press "manual function". You can select manual settings or press the left button to exit the interface.

In the manual interface, you can change the position of the heads using the up and down buttons.

If no fixed point or range is displayed in manual mode, you must select “massage adjustment” and then “Massage range” to adjust, press the left button to return. Navigate in the menu using the up and down buttons.

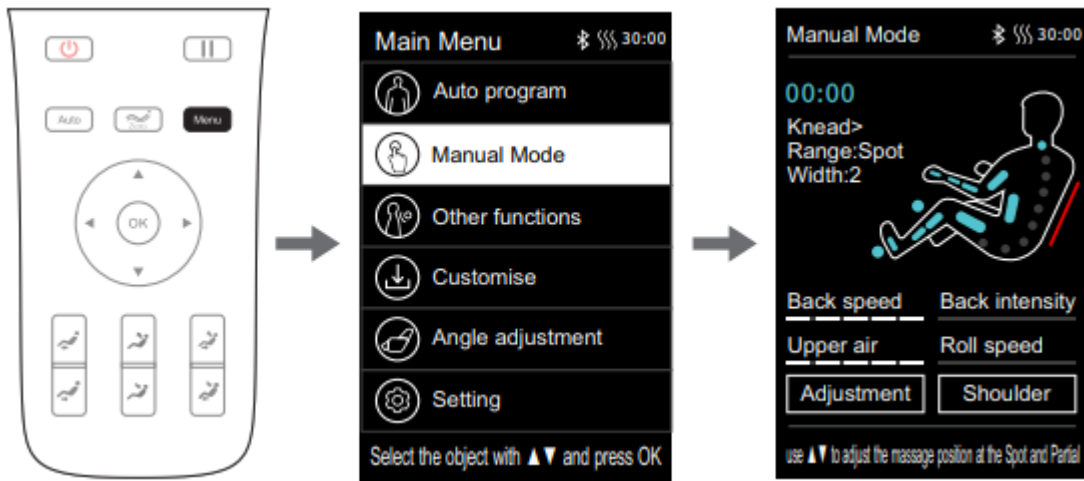

Note: The position of the heads cannot be adjusted in automatic mode.

## PAUSE

If the chair is in operation, press "pause" to temporarily stop, press repeatedly to start the massage. If the pause is longer than 20 minutes, the chair switches off.

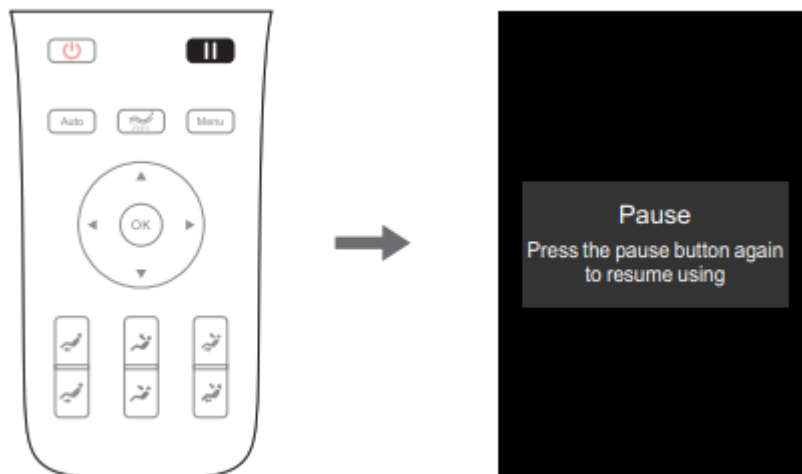

## MENU

Press "menu" to enter the menu interface. Navigate in the menu using the up and down buttons. Press "ok" to confirm, left button to return.

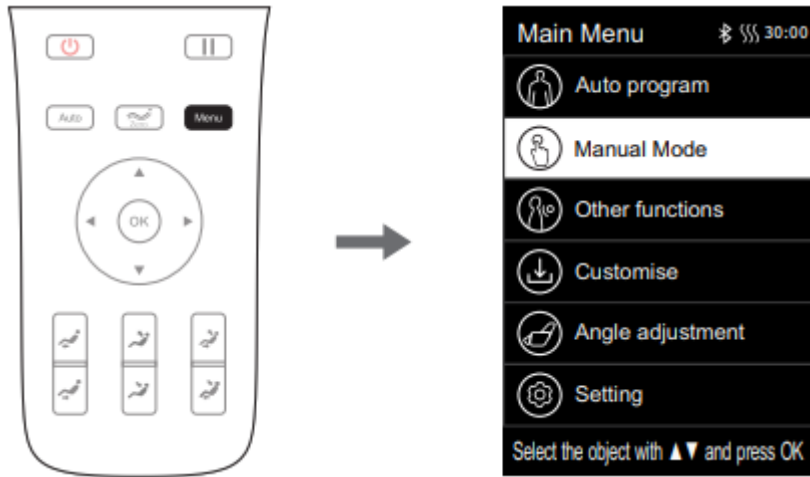

## AUTOMATIC MESSAGES

You can select automatic programs in the menu. Navigate in the menu using the up and down buttons. Confirm the selection by pressing "ok". Or you can press "auto" to enter the automatic message interface.

You can choose one of 21 preset messages: fast, comfortable, relaxing, stretching, full body, neck & shoulder massage, back & waist, anti-stress, to replenish energy, for good sleep, relaxation of joints, spine, for people with office work, for rest after sports, neck & shoulder relaxation, mind restoration, spine relaxation, waist relaxation, leg relaxation and recovery.

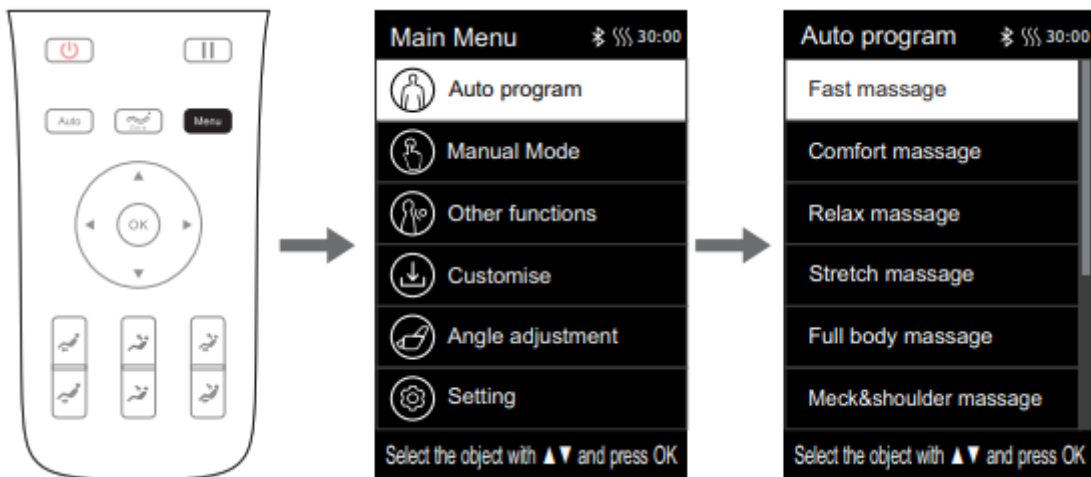

Message	Description
<b>fast</b>	Quick full body massage
<b>comfortable</b>	Comfortable massage
<b>relaxing</b>	Gentle, comfortable, and deep massage
<b>stretching</b>	Stretching the body from the feet through the waist to the back.
<b>full body</b>	Deep full body massage.
<b>neck &amp; shoulder</b>	Unique neck and shoulder massage.
<b>full airbag</b>	Back and waist massage.
<b>stress relieving</b>	Back and limb massage.
<b>energy</b>	Quick full body massage.

<b>good night sleep</b>	Massage the twelve main acupuncture points.
<b>joint care</b>	Joint massage.
<b>neck &amp; shoulder</b>	Neck and shoulder massage, improving blood circulation to the brain.
<b>spine massage</b>	Spine massage.
<b>office regiment</b>	Massage to improve body functions.
<b>sport recovery</b>	Quick massage.
<b>brain refresh</b>	Neck and shoulder massage.
<b>spine care</b>	Spine massage.
<b>waist care</b>	Waist massage.
<b>leg care</b>	Foot massage.
<b>rejuvenation</b>	Improving sleep quality.

The selected automatic massage will be displayed.

## MANUAL PROGRAMS

In the main menu, select manual mode.

You can select 11 techniques / functions: off, kneading, tapping I, tapping II, kneading and tapping, Shiatsu I, Shiatsu II, shoulder massage, 3D I, 3D II, 3D II, 3D IV and more.

Navigate in the menu using the up and down buttons, confirm the selection by pressing "ok", return to the previous menu by pressing the left button.

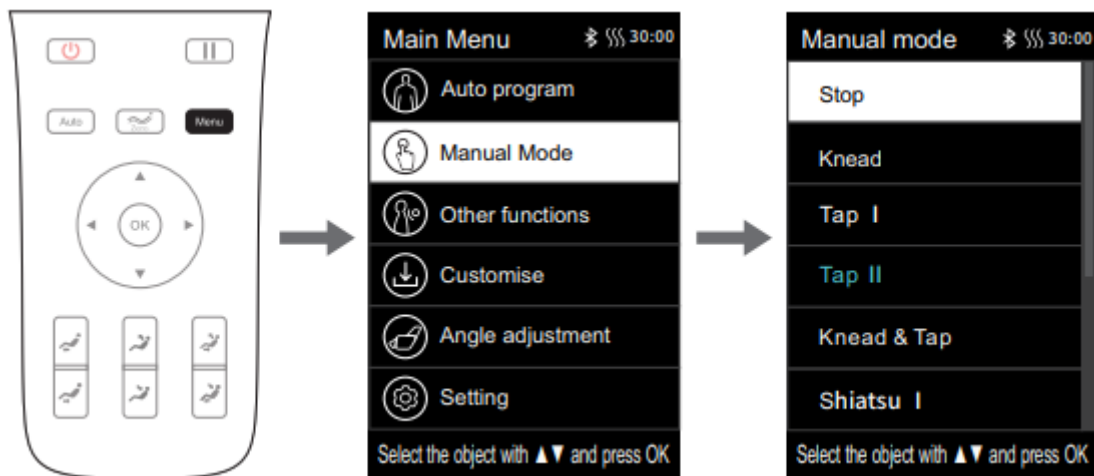

Function	Settings	
kneading	Speed	5 speed levels 5 levels of intensity
tapping	Width, speed	
kneading & tapping)	Speed	
Shiatsu	Width, speed	
shoulder lifting	Speed	
3D	Width, speed	

Note: In 3D massage mode, the width of 3D massage I and II cannot be set. The width can be set in 3D III and 3D IV modes.

## OTHER

In the main menu, select "other function" to enter the interface.

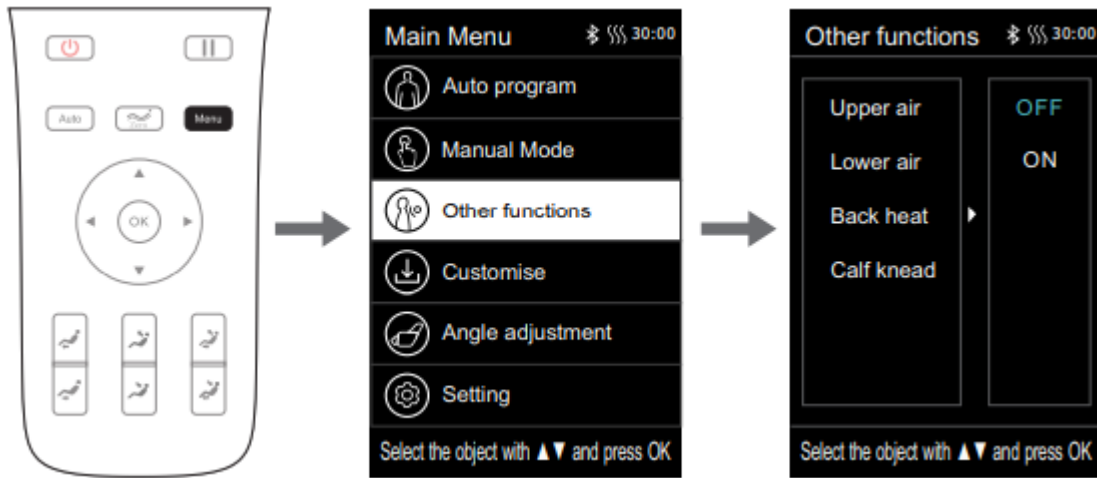

## UPPER BODY AIRBAGS

Upper body airbags: upper arms, arms, waist

Navigate in the menu with the up and down buttons, use the right button to switch the function on or off. Press "ok" to confirm the selection. The left buttons return to the previous interface.

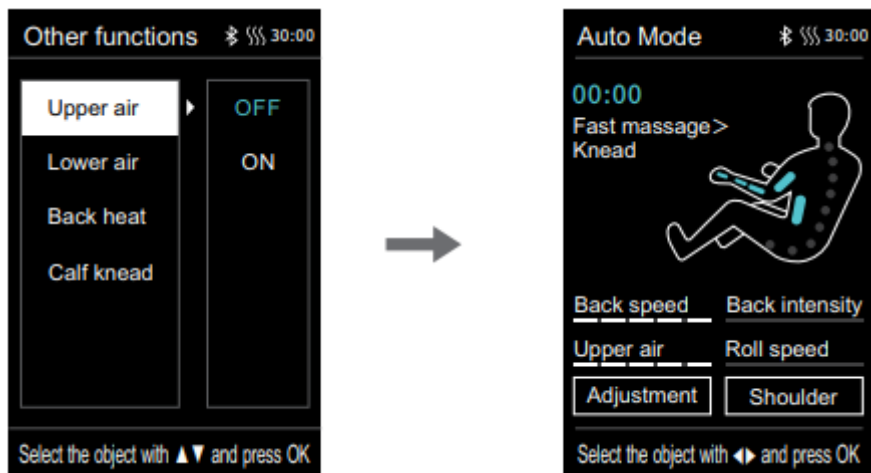

## LOWER BODY AIRBAGS

Lower body airbags: legs and feet.

Navigate in the menu with the up and down buttons, use the right button to switch the function on or off. Press "ok" to confirm the selection. The left buttons return to the previous interface.

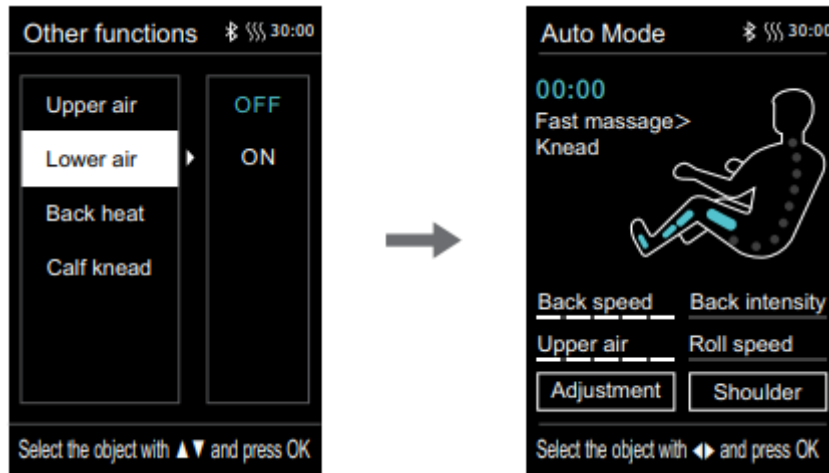

## HEATING

Heated backrest, heating is active after 3 minutes.

Navigate in the menu with the up and down buttons, use the right button to switch the function on or off. Press "ok" to confirm the selection. The left buttons return to the previous interface.

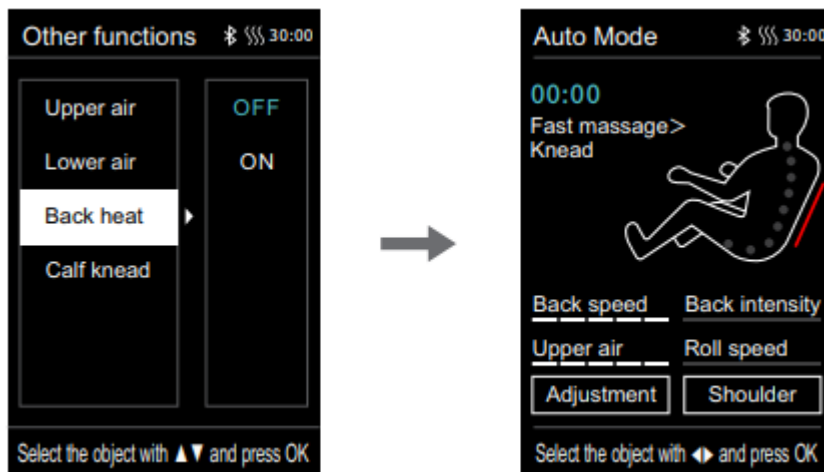

## LEG KNEADING

Navigate in the menu with the up and down buttons, use the right button to switch the function on or off. Press "ok" to confirm the selection. The left buttons return to the previous interface.

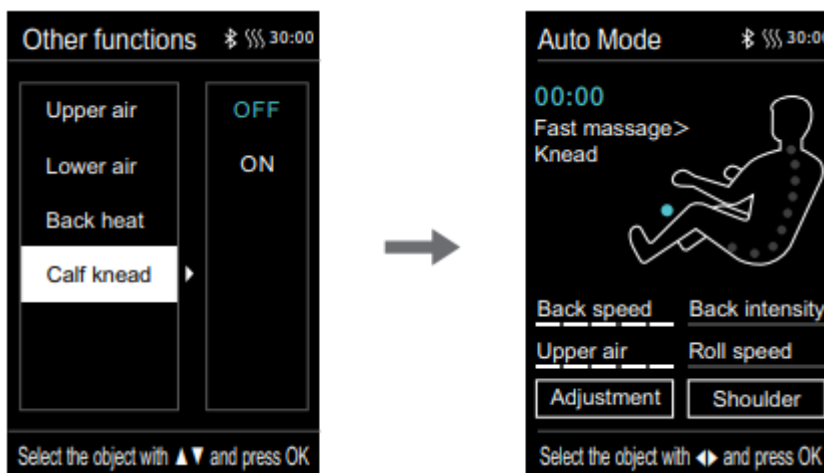

## CUSTOM MESSAGE

Select "customize" in the main menu. The "memory use", "memory save" and "cancel" interfaces are displayed.

Memory use: load a stored message M1, M2, M3, M4 and M5

Memory save: save messages to positions M1, M2, M3, M4 and M5

Cancel: cancellation

Note: While saving a message, you can name the saved message.

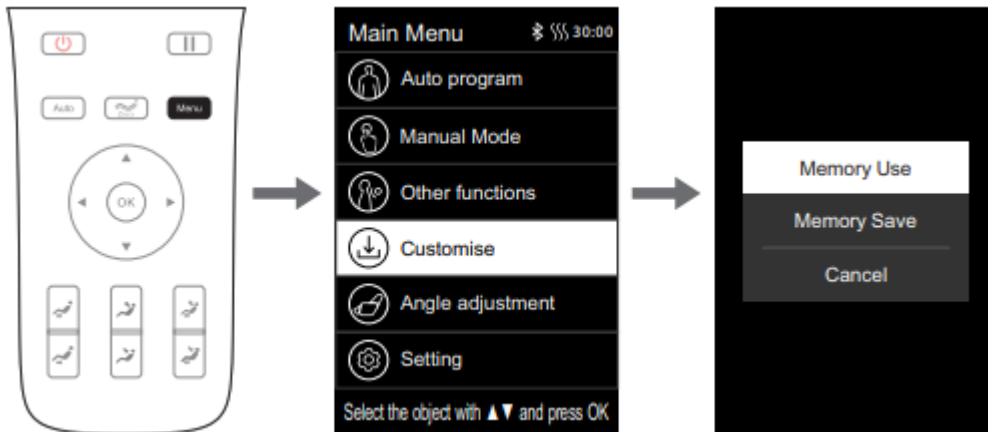

## SAVE

In the save interface, scroll with the up and down keys.

Select position M1 - M5.

Use "ok" to confirm the selection, press the left buttons to return to the previous menu.



Note: You can save notes for positions M1-M5.

## LOAD

Use the up and down buttons to navigate through the load interface.

Select position M1 - M5.

Use "ok" to confirm the selection, press the left buttons to return to the previous menu.



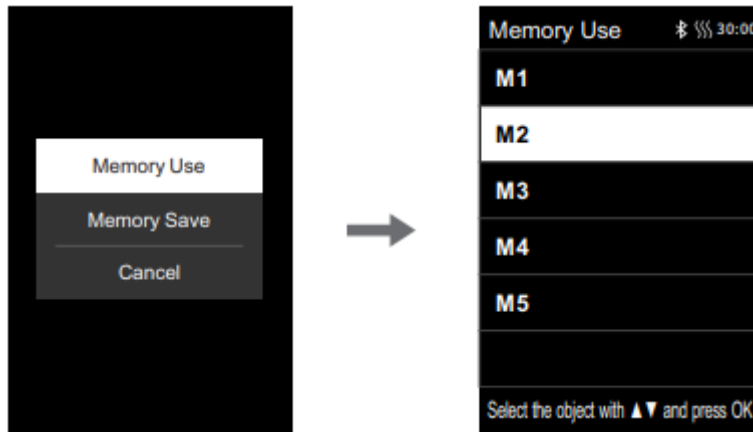

## ANGLE ADJUSTMENT

Navigate in the menu with the up and down buttons, use the right button to switch the function on or off. Press "ok" to confirm the selection. The left buttons return to the previous interface.

Select "angle adjustment" in the menu. In the sub menu there will be a choice of "whole body angle" of the whole body, "calf angle" footrest, "back angle" backrest, "zero-g" antigravity mode.

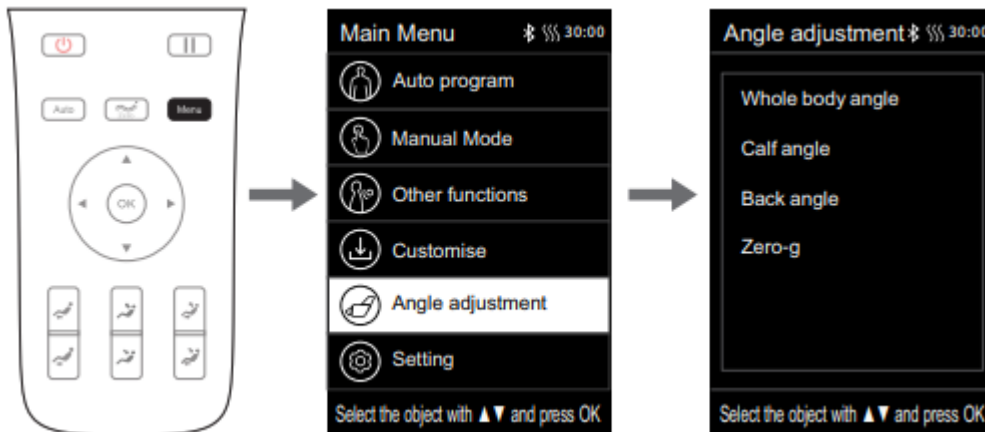

## LEG AND BACK REST ADJUSTMENT

Adjust the angle of the backrests and legs at the same time. (whole body angle)

Use the up and down buttons to adjust the angle. Press the left button to return to the previous interface.



## LEG ADJUSTMENT

Leg angle adjustment. (calf angle)

Use the up and down buttons to adjust the angle. Press the left button to return to the previous interface.

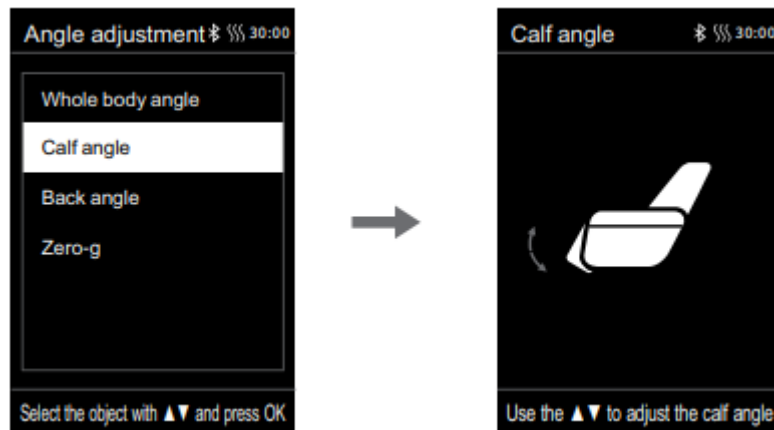

### BACKREST ANGLE

Backrest angle. (back angle)

Use the up and down buttons to adjust the angle. Press the left button to return to the previous interface.



### ZERO GRAVITY

In the zero-gravity setting, there are 3 modes to choose from and off.

Use the up and down buttons to select the mode. Press the left button to return to the previous interface.



## SETTINGS

In the main menu, select Setting to enter the settings.

In the menu, use the up and down buttons to move between the settings, the right buttons to enter the setting, the right button to select the setting, the "ok" buttons to confirm the selection and the left button to return to the previous interface.

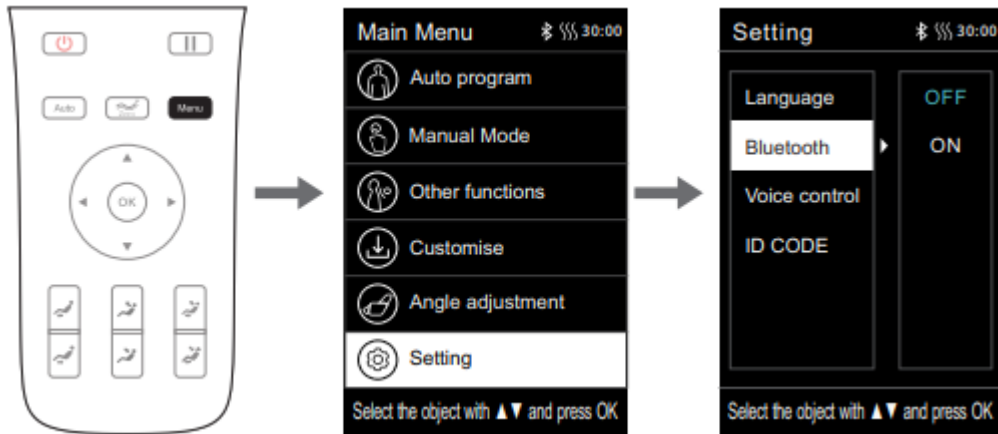

### LANGUAGE

You can choose between English and Chinese.

Press "ok" to confirm the selection. To return to the previous interface, press the left button.

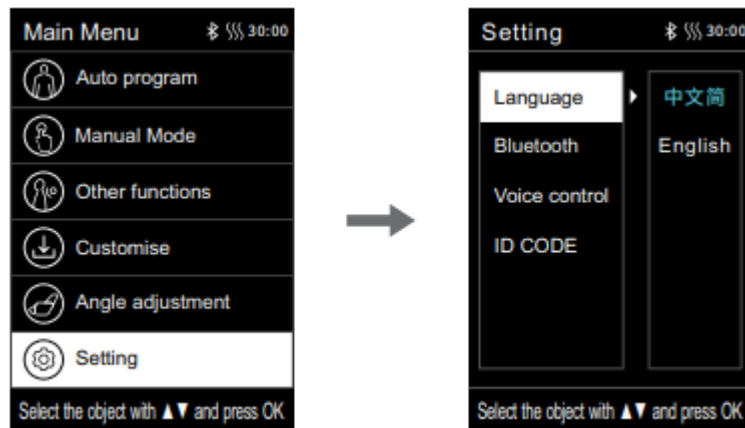

### BLUETOOTH

Bluetooth is initially turned off, you must turn Bluetooth on to pair the device.

Press "ok" to confirm the selection. To return to the previous interface, press the left button.

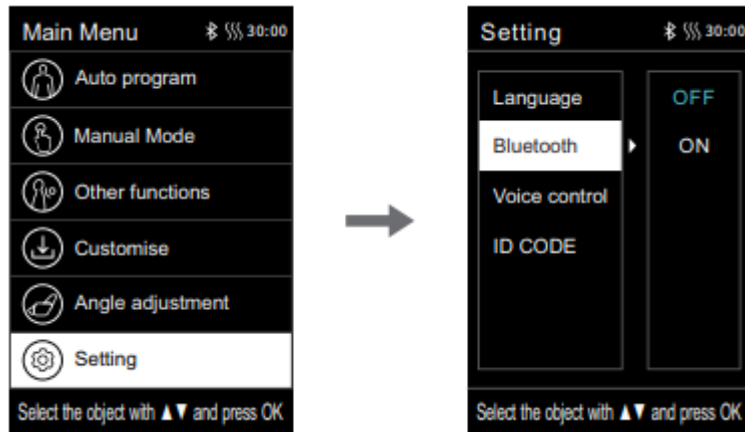

## VOICE CONTROL

You can turn voice control off / on.

Press "ok" to confirm the selection. To return to the previous interface, press the left button.

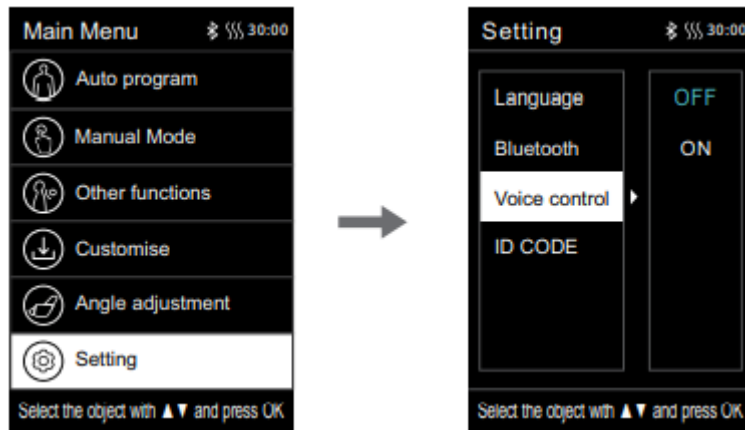

## ID

Display ID.

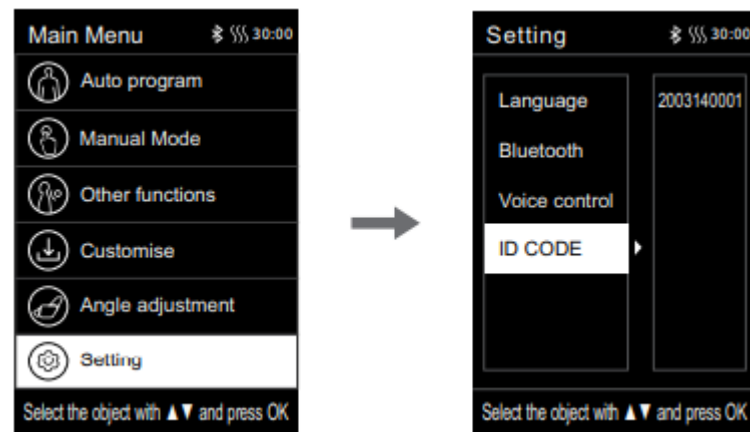

## MESSAGE ADJUSTMENT

In the information interface, press the right and left buttons to select the "adjustment" setting. Press "ok" to confirm the selection.

You can adjust 7 functions: "back speed", "back intensity", "massage area", "massage width", "air intensity", "roll speed" and massage time.

Use the up and down buttons to select a function. Then press the right button to enter the setting. Press "Ok" to confirm the selection and press left to return to the previous interface.

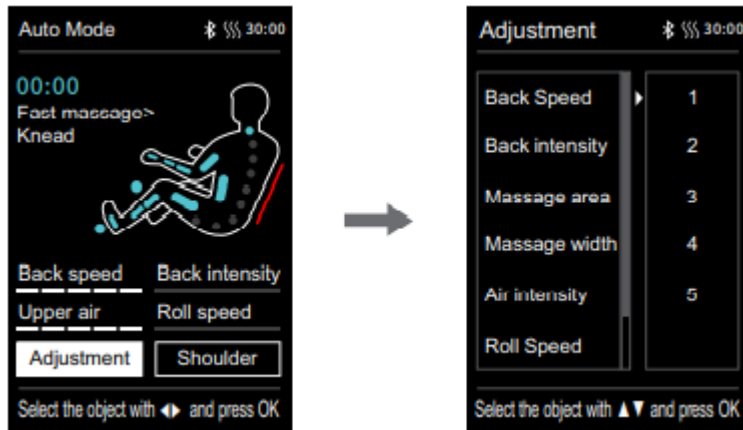

Function	Description
<b>Back speed</b>	5 levels of back massage speed setting
<b>Back intensity</b>	5 levels of back massage intensity setting
<b>Massage area</b>	5 locations for massage: fixed, partial, whole body, upper back, lower back
<b>Massage width</b>	5 massage width settings
<b>Air intensity</b>	5 levels of airbag intensity adjustment
<b>Roll speed</b>	3 speeds: 1 - 3, and off
<b>Massage time</b>	4 time settings: +10 min, +5 min, -5 min, -10 min

Note: Adjusting the massage time is only possible if the total massage time does not exceed 40 minutes. (eg if the massage time is 39 min, the time setting -5 min, -10 min will be displayed).

Adjusting the airbag intensity is only possible if the airbags are enabled.







### ZERO-GRAVITY

Press the zero gravity button to set the mode. Press repeatedly to select 3 modes, press 4x to return to the original setting.



Button	Description
	Pressing the button changes the inclination of the back and leg support, pressing it repeatedly changes the position, after 4 presses the position returns to its original position.







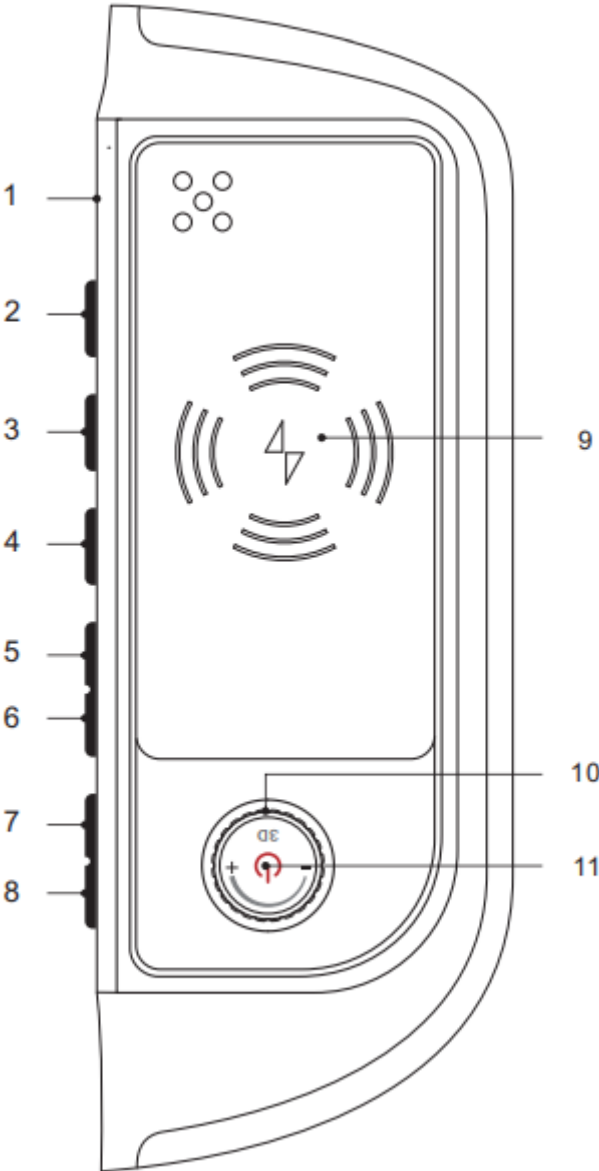

## ADJUSTMENT BUTTONS

Button	Description
	Raising the leg rest: holding down will slowly raise the footrest, release the button to stop.
	Lowering the leg rest: holding down will slowly lower the footrest, release the button to stop.
	Raising the backrest: holding down will slowly raise the backrest, release the button to stop.
	Lowering the backrest: holding down will slowly lower the backrest, release the button to stop.
	Lowering the leg rest, raising the backrest: holding down will slowly lower the leg rest and raise the backrest, release the button to stop.
	Raising the leg rest, lowering the backrest: holding down will slowly lower the backrest and raise the leg rest, release the button to stop.

# QUICK SELECTION BUTTONS



- 1. Voice control microphone
- 2. Automatic massage
- 3. Button for activating voice control, press and hold for 3 seconds to switch on / off
- 4. Heating
- 5. Lowering the leg rest
- 6. Raising the leg rest
- 7. Rise
- 8. Lower
- 9. Wireless charger
- 10. Adjusting the intensity of the 3D massage
- 11. Power switch, hold for 2 seconds to turn on / off

Button	Description
	Press to pause / start the massage, hold for 3 seconds to turn on / off the chair. If the massage is paused for more than 20 minutes, it switches off.
	3D massage intensity setting, range 1-5
	By holding down the button, the backrest starts to raise, and the leg rest lowers. Release the button to stop.
	By holding down the button, the backrest starts to lower, and the leg rest raises. Release the button to stop.
	Holding down the button rise the leg rest. Release the button to stop.
	By holding down the button, the leg rest starts to lower. Release the button to stop.
	Press the button to switch the heating on / off.
	Hold down the button for 3 seconds to turn on / off voice control. Press the button to activate voice control for 6 seconds, then deactivate again.
	Press to select automatic massage.

## VOICE CONTROL

Voice control of the chair is in English only.

If the chair is turned on or in standby mode, say "Hi Alice" to start voice control. After starting the voice control, you have 6 seconds to enter the next command. After 6 seconds, the voice control switches off again.

No.	Command	Answer
1.	Massage on	ok, massage on.
2.	Massage close	ok, massage close
3.	Comfort Massage.	ok, comfort massage
4.	Relax massage.	ok, relax massage
5.	Full body massage.	ok, full body massage
6.	Neck and shoulder massage.	ok, Neck and shoulder massage
7.	Back and waist massage.	ok, back and waist massage
8.	Stretch massage.	ok, stretch massage
9.	Fixed massage.	ok, fixed massage
10.	Change the other mode.	ok, change the other mode
11.	Go little down.	ok, go little down
12.	Go little up.	ok, go little up



- |     |                         |                            |
|-----|-------------------------|----------------------------|
| 13. | Open the air pressure.  | ok, open the air pressure  |
| 14. | Close the air pressure. | ok, close the air pressure |
| 15. | Up the seat position.   | ok, up the seat position   |
| 16. | Down the seat position. | ok, down the seat position |
| 17. | Stop adjustment.        | ok, stop adjustment        |

## BLUETOOTH

Find your new device on your phone. The chair will be called IMCM-XXXX (X is the unique number of the chair). Pair the chair with your phone and you can play music from your phone.

## SWITCH OFF THE CHAIR

Press the power button to turn off the chair. The massage functions are switched off, the positions of the armrests are switched to the default positions.

To switch off completely, switch the switch on the left side of the chair to the off position.



## ASSEMBLY

### ARM RESTS

Connect the controller and power cord to an electrical outlet. The chair switches to emergency mode and sets all parts to the default position. Then switch off and unplug the chair (Fig. 1).

Connect the support cables and hoses (Fig. 2).

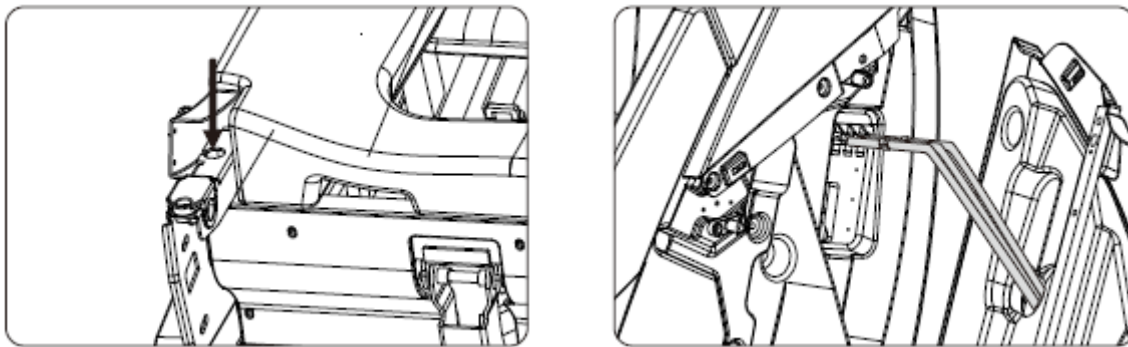

1

2

Grasp the armrest with both hands and slide it into the middle hook (Fig. 3).

Do not pinch any cables or hoses, attach the armrest to the chair (Fig. 4).

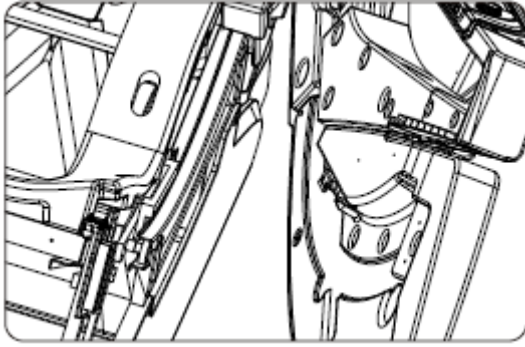

3

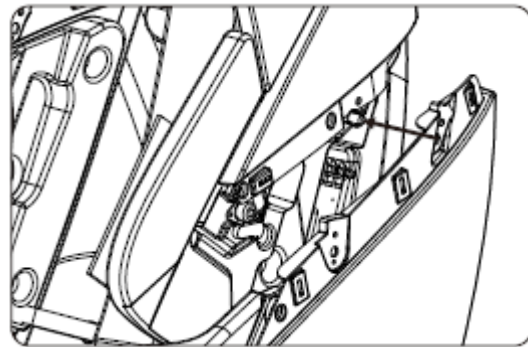

4

Secure the back with 2x M6 screws (Fig. 5).

Secure the front with 2x M6 screws (Fig. 6).

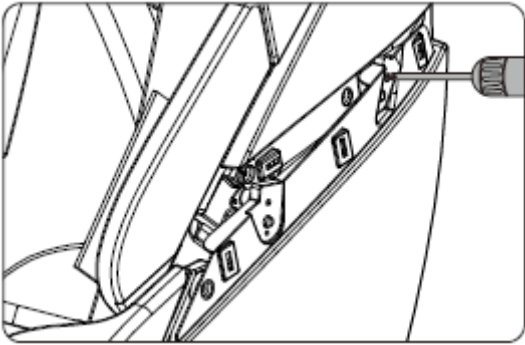

5

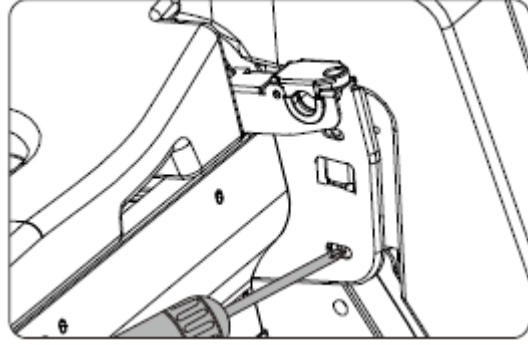

6

Attach the cover (Fig. 7)

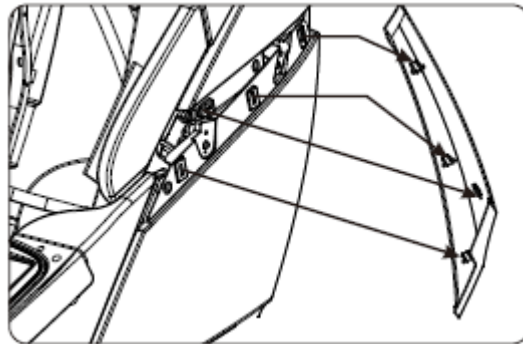

7

## LEG RESTS

Connect the cables and hoses (Fig. 1).

Attach the leg rest to the brackets (Fig. 2).

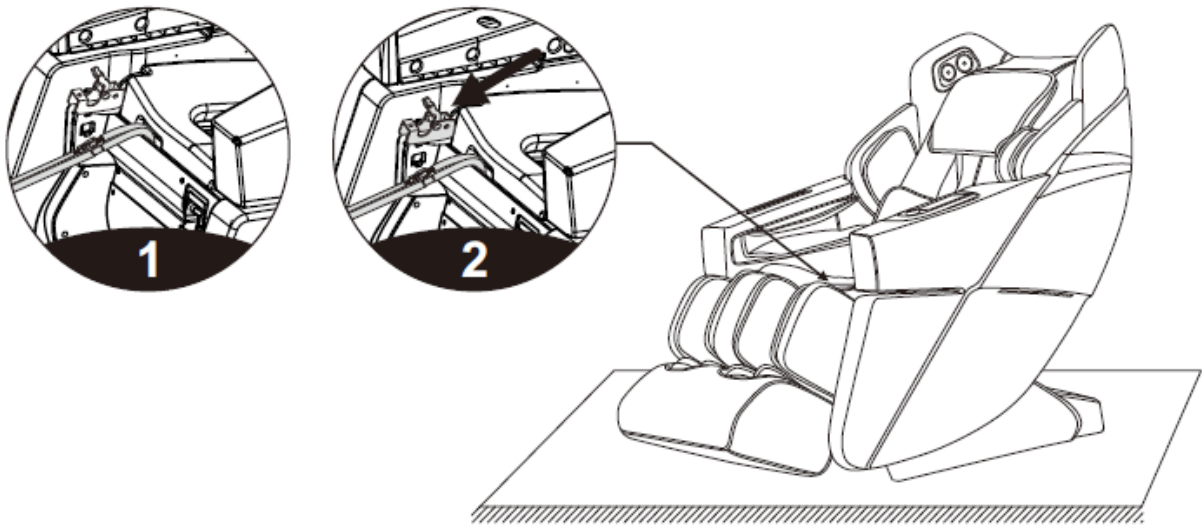

Attach the covers to the brackets (Fig. 3).

Attach the covers with 2x M5 screws on each side (Fig. 4).

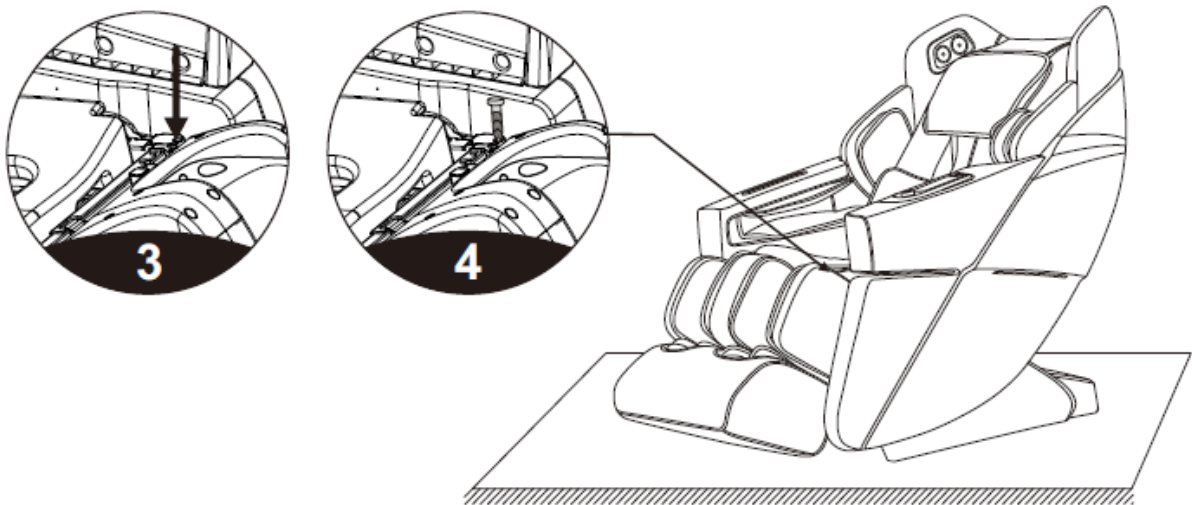

## PILLOWS

The cushions are fastened with a zipper for the backrest (1), the cushions for the headrest with Velcro (2).

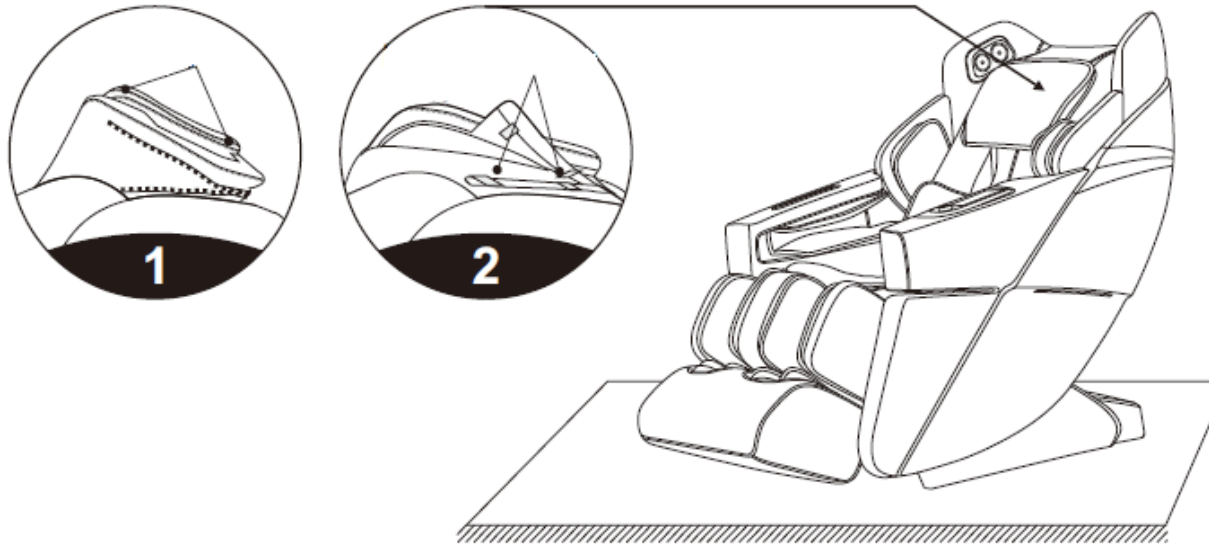

## FLOOR PROTECTION

We recommend using floor protection such as carpets or mats. The weight of the chair could damage the wooden floor.

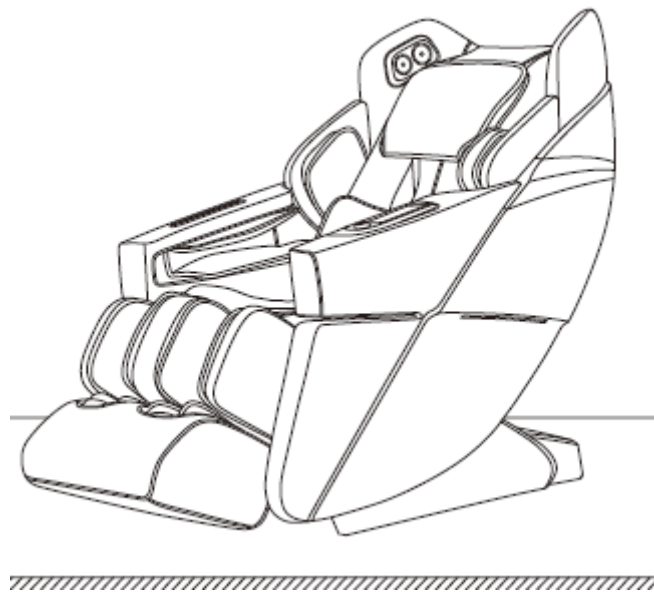

## TRANSPORT

Before moving, make sure that you have switched off the chair and pulled it out of the power.

You need two people to move.

One person lifts the chair by the footrest and the other pushes by the backrest, thus placing the chair on the wheels. Do not pull the chair by the armrests.

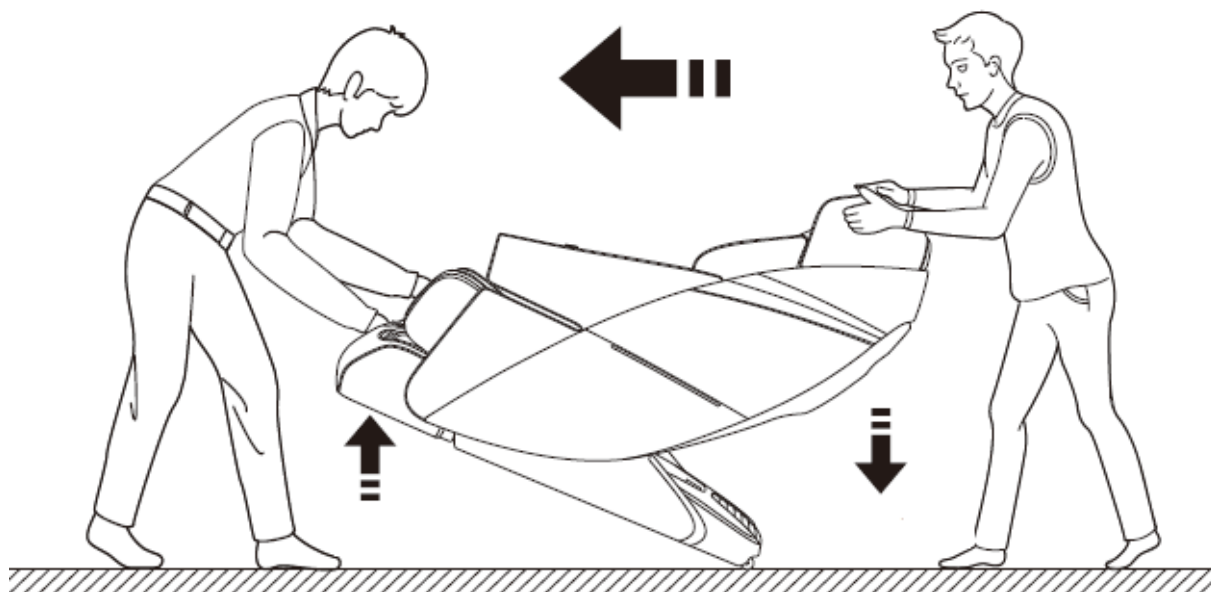

## SPECIFIKACE

Model:	A601
Name:	Massage armchair
Rated voltage:	110-120V 60 Hz 220-240V 50Hz/60Hz
Rated power input	220 W
Timer	20 min

## ENVIRONMENT PROTECTION

After the product lifespan expired or if the possible repairing is uneconomic, dispose it according to the local laws and environmentally friendly in the nearest scrapyard.

By proper disposal you will protect the environment and natural sources. Moreover, you can help protect human health. If you are not sure in correct disposing, ask local authorities to avoid law violation or sanctions.

Don't put the batteries among house waste but hand them in to the recycling place.

## TERMS AND CONDITIONS OF WARRANTY, WARRANTY CLAIMS

### General Conditions of Warranty and Definition of Terms

All Warranty Conditions stated here under determine Warranty Coverage and Warranty Claim Procedure. Conditions of Warranty and Warranty Claims are governed by Act No. 89/2012 Coll. Civil Code, and Act No. 634/1992 Coll., Consumer Protection, as amended, also in cases that are not specified by these Warranty rules.

The seller is SEVEN SPORT s.r.o. with its registered office in Strakonická street 1151/2c, Prague 150 00, Company Registration Number: 26847264, registered in the Trade Register at Regional Court in Prague, Section C, Insert No. 116888.

According to valid legal regulations it depends whether the Buyer is the End Customer or not.

“The Buyer who is the End Customer” or simply the “End Customer” is the legal entity that does not conclude and execute the Contract in order to run or promote his own trade or business activities.

“The Buyer who is not the End Customer” is a Businessman that buys Goods or uses services for the purpose of using the Goods or services for his own business activities. The Buyer conforms to the General Purchase Agreement and business conditions.

These Conditions of Warranty and Warranty Claims are an integral part of every Purchase Agreement made between the Seller and the Buyer. All Warranty Conditions are valid and binding, unless otherwise specified in the Purchase Agreement, in the Amendment to this Contract or in another written agreement.

### **Warranty Conditions**

#### Warranty Period

The Seller provides the Buyer a 24 months Warranty for Goods Quality, unless otherwise specified in the Certificate of Warranty, Invoice, Bill of Delivery or other documents related to the Goods. The legal warranty period provided to the Consumer is not affected.

By the Warranty for Goods Quality, the Seller guarantees that the delivered Goods shall be, for a certain period of time, suitable for regular or contracted use, and that the Goods shall maintain its regular or contracted features.

#### **Batteries**

6-month battery warranty – we guarantee that battery's nominal capacity does not fall below 70% of its total capacity within 6 months of the product's sale.

#### **The Warranty does not cover defects resulting from (if applicable):**

- User's fault, i.e. product damage caused by unqualified repair work, improper assembly, insufficient insertion of seat post into frame, insufficient tightening of pedals and cranks
- Improper maintenance
- Mechanical damages
- Regular use (e.g. wearing out of rubber and plastic parts, moving mechanisms, joints, wear of brake pads/blocks, chain, tires, cassette/multi wheel etc.)
- Unavoidable event, natural disaster
- Adjustments made by unqualified person
- Improper maintenance, improper placement, damages caused by low or high temperature, water, inappropriate pressure, shocks, intentional changes in design or construction etc.

### **Warranty Claim Procedure**

The Buyer is obliged to check the Goods delivered by the Seller immediately after taking the responsibility for the Goods and its damages, i.e. immediately after its delivery. The Buyer must check the Goods so that he discovers all the defects that can be discovered by such check.

When making a Warranty Claim the Buyer is obliged, on request of the Seller, to prove the purchase and validity of the claim by the Invoice or Bill of Delivery that includes the product's serial number, or eventually by the documents without the serial number. If the Buyer does not prove the validity of the Warranty Claim by these documents, the Seller has the right to reject the Warranty Claim.

If the Buyer gives notice of a defect that is not covered by the Warranty (e.g. in the case that the Warranty Conditions were not fulfilled or in the case of reporting the defect by mistake etc.), the Seller is eligible to require a compensation for all the costs arising from the repair. The cost shall be calculated according to the valid price list of services and transport costs.

If the Seller finds out (by testing) that the product is not damaged, the Warranty Claim is not accepted. The Seller reserves the right to claim a compensation for costs arising from the false Warranty Claim.

In case the Buyer makes a claim about the Goods that is legally covered by the Warranty provided by the Seller, the Seller shall fix the reported defects by means of repair or by the exchange of the damaged part or product for a new one. Based on the agreement of the Buyer, the Seller has the right

to exchange the defected Goods for a fully compatible Goods of the same or better technical characteristics. The Seller is entitled to choose the form of the Warranty Claim Procedures described in this paragraph.

The Seller shall settle the Warranty Claim within 30 days after the delivery of the defective Goods, unless a longer period has been agreed upon. The day when the repaired or exchanged Goods is handed over to the Buyer is considered to be the day of the Warranty Claim settlement. When the Seller is not able to settle the Warranty Claim within the agreed period due to the specific nature of the Goods defect, he and the Buyer shall make an agreement about an alternative solution. In case such agreement is not made, the Seller is obliged to provide the Buyer with a financial compensation in the form of a refund.

**CZ**  
**SEVEN SPORT s.r.o.**

Registered Office: Strakonická 1151/2c, Praha 5, 150 00, ČR  
Headquarters: Dělnická 957, Vítkov, 749 01  
Warranty & Service: Čermenská 486, Vítkov 749 01

CRN: 26847264  
VAT ID: CZ26847264

Phone: +420 556 300 970  
E-mail: eshop@insportline.cz  
reklamace@insportline.cz  
servis@insportline.cz

Web: www.inSPORTline.cz

**SK**  
**inSPORTline s.r.o.**

Headquarters, warranty & service center: Električná 6471, Trenčín 911 01, SK

CRN: 36311723  
VAT ID: SK2020177082

Phone: +421(0)326 526 701  
E-mail: objednavky@insportline.sk  
reklamacie@insportline.sk  
servis@insportline.sk

Web: www.inSPORTline.sk