



USER MANUAL – EN

IN 7120 Inversion Table inSPORTline Inverso



The specifications of this product may vary from this photo, subject to changes without notice.

CONTENTS

- 1. WARNING..... 3
- 2. SAFETY PRECAUTIONS..... 3
- 3. PARTS LIST 4
- 4. HARDWARE & TOOLS 5
- 5. ASSEMBLY INSTRUCTIONS 6
- 6. BALANCING THE INVERSION TABLE 7
- 7. USING THE INVERSION TABLE..... 7
- 8. SUGGESTIONS FOR USE 8
- 9. LOCKING THE BED..... 8

1. WARNING

Before using the Confidence Pro Folding Inversion table, please, consult your physician. This is extremely important for people with pre-existing medical conditions. Do not use the Confidence Pro Folding Inversion table if you have any of the following conditions:











- Extreme Obesity
- Glaucoma, Retinal Detachment or Conjunctivitis
- Pregnancy
- Spinal Injuries, Cerebral Sclerosis or swollen joints
- Middle Ear Infection
- High Blood pressure, Hypertension, a history of a Stroke or Transient Ischemic Attacks
- Heart or Circulatory Disorders for which you are being treated.
- Hiatus Hernia or Ventral Hernia
- Bone Weaknesses, Osteoporosis, unhealed Fractures, Modularly Pins or Surgically Implanted
- Orthopedic Supports
- Use Anti-Coagulants including Aspirin in high doses

2. SAFETY PRECAUTIONS

The Confidence Pro Folding Inversion Table was designed for optimum safety; however certain precautions apply whenever it is in use.









- Always wear proper exercise apparel when using the Confidence Pro Folding Inversion Table.
- If at any time you feel weak or dizzy, stop exercising immediately and consult your physician.
- Keep children and pets away from the Confidence Pro Folding Inversion Table at all times.
- This Confidence Pro Folding Inversion Table is only designed to be used by one person at a time
- Please ensure that the Confidence Pro Folding Inversion Table is assembled according to the instructions, be sure all screws, nuts and bolts are tightened prior to use.
- If the Confidence Pro Inversion Table has been damaged in anyway please stop use immediately.
- Please be sure to monitor your body's symptoms, make sure you come up slowly. If you experience any dizziness this means that you have come up too fast. If you are nauseous come up immediately.
- The Confidence Pro Folding Inversion Table is to be set up on a flat level surface, do not use outdoors or near water.
- Please make sure that there is a 2 m radius around the Confidence Pro Folding Inversion Table at all times.
- Keep hands and feet away from all moving parts
- Keep loose clothing and jewelry away from all moving parts.
- Class - H (according to EN ISO 20957) for home use.
- User weight should not exceed 130 kg.

3. PARTS LIST

<p>A</p>  <p>Under frame assembly 1pc</p>	<p>B₁</p>  <p>B₂</p>  <p>Bed 1pc</p>	<p>C</p>  <p>Adjustable boom 1pc</p>	
<p>D</p>  <p>Handle bar 2pcs</p>	<p>E</p>  <p>Pivot Arm 2pcs</p>	<p>F</p>  <p>Protective Cover 2pcs</p>	<p>G</p>  <p>Belt 1pc</p>
<p>H</p>  <p>Foot bar 1pc</p>	<p>I</p>  <p>(Sponge) Heel holder ROD 1pc</p>	<p>J</p>  <p>(Rubber) Heel holder ROD 1pc</p>	

4. HARDWARE & TOOLS



<p>1 $d+2h+e$</p>  <p>Screw: M8 × 55, 2sets</p>	<p>2 $c+2h+e$</p>  <p>Screw: M8 × 45, 2sets</p>	<p>3 $a+2h+e$</p>  <p>Screw: M8 × 20, 2sets</p>	
<p>4 $b+f+g$</p>  <p>Screw: M6 × 45, 2sets</p>		<p>6</p>  <p>Plum blossom knob, 1pc</p>	
<p>7</p>  <p>Screw-driver, 1pc</p>	<p>8</p>  <p>Spanner, 1pc</p>	<p>9</p>  <p>Spanner, 1pc</p>	

5. ASSEMBLY INSTRUCTIONS

Step 1

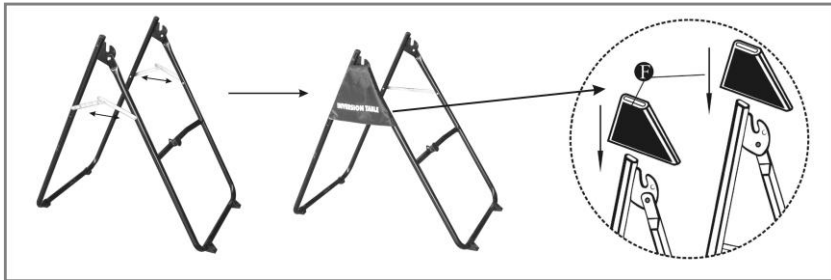

Step 2

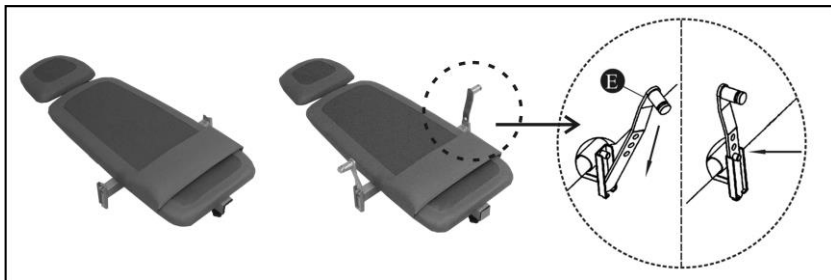

Step 3

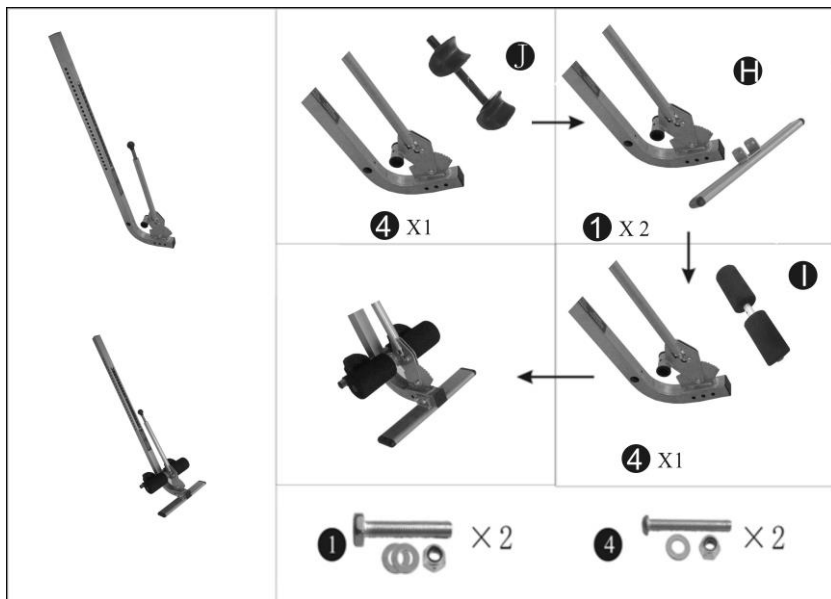

Step 4

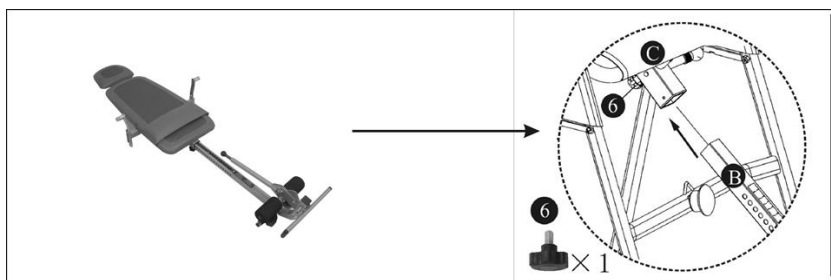

Step 5



6. BALANCING THE INVERSION TABLE

The inversion table is like a very sensitively balanced fulcrum. It responds to very slight changes in weight distribution. So, it is very important to make sure that the height is adjusted properly. To do this, mount the machine, lock your ankles into the heel holders, and lie back with your hands at your sides. Slowly place your hands across your chest. While in this position, your head should still be above your feet. If your feet are above your head, dismount and adjust the height again.

7. USING THE INVERSION TABLE

1. Start by lying fully back on the bed with your hands at your side, or resting on your thighs.
2. Keeping your hands close to your body begin to raise your arms slowly allowing the table to rotate backward. Stop, or lower your arms to control the downward rotation of the table
3. Raise your arms until they are over your head. At this point, the inversion table will be as far back as it can go.
4. As you get more comfortable, rock the bed slowly by moving your arms up and low slowly.
5. It is recommended that the inversion table be used for five or ten minutes each morning and again each evening.
6. Return to the upright position by slowly moving your hands back down to your thighs.

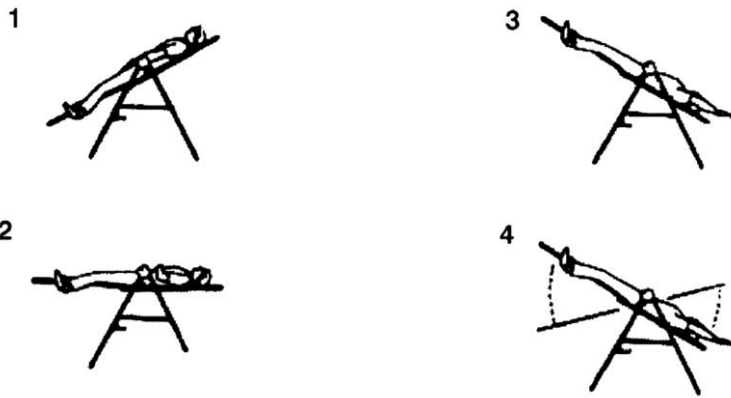

8. SUGGESTIONS FOR USE

1. **Begin slowly:** invert only 15~20 degrees to begin with. Stay inverted only as long as you are comfortable. Return upright slowly.
2. **Make gradual changes:** Increase the angle only if it is comfortable. Increase angle only a few degrees at a time. Increase the time of use 1~2 minutes up to ten over a period of weeks. Add stretching and light exercise only after you are comfortable with inversion.
3. **Watch your body:** come up slowly. Dizziness after a session means you came up too fast. Wait a while after eating before using table. Coming up immediately if you feel nauseous.
4. **Keep moving:** movement while inverted encourages blood circulation. Movement may be accomplished by either rhythmic traction or light exercise. Do not exercise strenuously while inverted, Limit partial inversion without movement to one or two minutes. Limit full inversion with no movement to only a few seconds.
5. **Invert regularly:** we recommend two or three times a day depending upon your current condition. Try to schedule it for the same times each day.



9. LOCKING THE BED

When the inversion table rotates past the vertical Inverted position the bed becomes locked. And will not return to the upright position in the usual way. The locked position allows you to hang straight upside-down completely free of the bed. This position allows you to enjoy all of the benefits of a handstand, with none of the discomforts. It also allows you to do exercises such as the waistband. To get into the locked position adjust the pivot arms so the studs go through the top holes and then mount and use normally. When your arms are completely extended above your head, the bed will rotate all the way to the locked position.

To recover from the locked position, simply grab the handlebars and pull on them while pushing back on the heel holders with your legs. If you cannot reach the handlebars than you can still recover by grabbing the back of the bed with one hand, the rear u-frame with the other, and pulling your hands together.